



Bid Notice Abstract

Request for Quotation (RFQ)

Reference Number 12959479
Procuring Entity CARLOS HILADO MEMORIAL STATE UNIVERSITY
Title Procurement of Labor and Materials for the Installation of Dry Wall Partition and Window Grills for RAC Shop Laboratory Extension at Talisay Campus
Area of Delivery Negros Occidental

Solicitation Number:	RFQ 26-138	Status	Pending
Trade Agreement:	Implementing Rules and Regulations	Associated Components	3
Procurement Mode:	Negotiated Procurement - Small Value Procurement (Sec. 53.9)	Bid Supplements	0
Classification:	Civil Works	Document Request List	0
Category:	Construction Projects	Date Published	05/05/2026
Approved Budget for the Contract:	PHP 210,000.00	Last Updated / Time	04/05/2026 09:55 AM
Delivery Period:	45 Day/s	Closing Date / Time	12/05/2026 09:00 AM
Client Agency:			
Contact Person:	Rowena De la Vida Prado Administrative Assistant II Mabini Street Talisay City Negros Occidental Philippines 6115 63-34-7120005 Ext.142 63-939-9296624 bac.sec@chmsu.edu.ph		

Description

Republic of the Philippines
 CARLOS HILADO MEMORIAL STATE UNIVERSITY
 Talisay City, Negros Occidental
 Mobile Phone Number: (0920) 583 3046
 bac.sec@chmsu.edu.ph

REQUEST FOR QUOTATION

Page 1 of 6
 Date: APRIL 29, 2026
 Quotation No. 26-138

Please quote your lowest price on the item/s listed below, stating the shortest time of delivery and submit your quotation duly signed by your representative not later than _____ in the return envelope attached herewith.

DR. MA. RIZA T. MANALO
 BAC Chairperson

NOTE:

- ALL ENTRIES MAY BE TYPEWRITTEN OR LEGIBLY HANDWRITTEN
- DELIVERY PERIOD WITHIN 45 CALENDAR DAYS
- WARRANTY SHALL BE FOR A PERIOD OF SIX (6) MONTHS FOR SUPPLIES & MATERIALS, ONE (1) YEAR FOR EQUIPMENT, FROM DATE OF ACCEPTANCE BY THE PROCURING ENTITY
- PRICE VALIDITY SHALL BE FOR A PERIOD OF _____ CALENDAR DAYS
- G-EPS REGISTRATION CERTIFICATE SHALL BE ATTACHED UPON SUBMISSION OF THE QUOTATION

SCOPE OF WORKS

1.0 GENERAL REQUIREMENTS

- 1.1 Mobilization and Demobilization
- 1.2 Safety Occupational Hazards
- 1.3 Site Clearing, Cleaning and Hauling

2.0 ARCHITECTURAL WORKS

2.1 CARPENTRY WORKS

- 2.1.1 Fabrication and Installation of Dry Wall Partition (Double Wall)
- 2.1.2 Fabrication and Installation of 2 unit Door, Door Jamb with complete Accessories (See Detail and Location Plan)

2.2 PAINTING WORKS

- 2.2.1 Surface Preparation and Painting of Dry Wall Partition
- 2.2.2 Surface Preparation and Painting of New Door and Door Jambs
- 2.2.3 Surface Preparation and Painting of Window Grills

3.0 MASONRY and TOUCH-UP PAINT WORKS

- 3.1 Touch-up paint and masonry work (for Installation of grills)

4.0 STEEL WORKS

- 4.1 Fabrication and Installation of 4 Units Window Grills for RAC Shop Laboratory Extension (See Detailed Plan)

5.0 MISCELLANEOUS WORKS

BILL OF QUANTITIES

1.0 GENERAL REQUIREMENTS

- 1.1 Mobilization and Demobilization 1.00 lot
 - 1.2 Safety Occupational Hazards 1.00 lot
 - 1.3 Site Clearing, Cleaning and Hauling 1.00 lot
- Sub-total, 1.0 (GENERAL REQUIREMENTS)

2.0 ARCHITECTURAL WORKS

2.1 CARPENTRY WORKS

DRY WALL PARTITIONS, DOOR, DOOR JAMB & ACCESSORIES

- 2.1.1 1/4"x 4"x 8' Fiber Cement Board 26 shts
 - 2.1.2 Super thin cutting disc 4" 3 box
 - 2.1.3 Grinding stone 4" 5 pcs
 - 2.1.4 1/8" x 1/2" Blind Rivets 2 box
 - 2.1.5 3"x2"x3m thk. Metal Studs 32 lgth
 - 2.1.6 Doorknob with lockset (Lever type) 2 pcs.
 - 2.1.7 "1.00m Width x 2.10m Height, Wood Panel Door with Door Jamb, Door Hinges Heavy Duty and Doorknob (Lever type) with Lock" 2 set
- Sub-total, 2.1 (CARPENTRY WORKS)

2.2 PAINTING WORKS

DRY WALL PARTITIONS, DOOR, DOOR JAMB & ACCESSORIES and GRILLS

- 2.2.1 Metal Primer, Gray / Red Oxide (for Grills) 4.00 gal
 - 2.2.2 Enamel Topcoat paint, Black (for Grills) 3.00 gal
 - 2.2.3 Flat Latex, White 8.00 gal
 - 2.2.4 Semi-gloss Latex, White 8.00 gal
 - 2.2.5 Paint tray 5.00 pcs
 - 2.2.6 Baby Roller 6.00 pcs
 - 2.2.7 2" Paint Brush 5.00 pcs
 - 2.2.8 #120 Sanding paper 4.00 pcs
 - 2.2.9 #60 Sanding paper 4.00 pcs
 - 2.2.10 #400 Sanding paper 5.00 pcs
 - 2.2.11 Waste Cotton 5.00 kls
 - 2.2.12 Paint Thinner 4.00 gal
 - 2.2.13 Masonry Putty 6.00 liters
 - 2.2.14 Masking Tape 1" 9.00 roll
 - 2.2.15 Wood Stain (Mahogany) (for Proposed 2 Unit Door) 4.00 liter
 - 2.2.16 Sanding Sealer 4.00 liter
 - 2.2.17 Lacquer thinner 2.00 gal
- Sub-total, 2.2 (PAINTING WORKS)

3.0 MASONRY and TOUCH-UP PAINT WORKS

- 3.1 Touch-up paint and masonry work (for Installation of grills) 1.00 lot
- Sub-total, 3.0 (MASONRY and TOUCH-UP PAINT WORKS)

4.0 STEEL WORKS

FABRICATION AND INSTALLATION OF 8 UNITS WINDOW GRILLS FOR RAC SHOP LABORATORY EXTENSION

- 4.1 10mm x 10mm x 6m Steel Square Bar 85.00 lgths.
 - 4.2 6013 Welding Rod 12.00 kgs.
 - 4.3 4"Ø Steel Cutting Disc 15.00 pcs
 - 4.4 4"Ø Grinding Stone 6.00 pcs
- Sub-total, 4.0 (STEEL WORKS)

5.0 MISCELLANEOUS WORKS

FOR ALL OTHER ITEMS that are not included on listed Bill of Quantities in your Bid, but are deemed necessary for the completion of the works. 1.00 lot

Sub-total, 5.0 (MISCELLANEOUS WORKS)

PROJECT DURATION: 45 CALENDAR DAYS

Note: Attach Certificate of Site Inspection

A. TOTAL DIRECT COST

B. CONSUMABLES:

C. SUPERVISION AND ADMINISTRATION:

D. TOTAL INDIRECT COST (B+C):

E. TOTAL COST (A+D)

Line Items					
Item No.	Product/Service Name	Description	Quantity UOM		Budget (PHP)
1	ONE (1) LOT	Labor and Materials for the Installation of Dry Wall Partition and Window Grills for RAC Shop Laboratory Extension at Talisay Campus	1	Lot	210,000.00

Created by Rowena De la Vida Prado

Date Created 04/05/2026

The PhilGEPS team is not responsible for any typographical errors or misinformation presented in the system. PhilGEPS only displays information provided for by its clients, and any queries regarding the postings should be directed to the contact person/s of the concerned party.

© 2004,2004-2026 DBM Procurement Service. All rights reserved.,DBM Procurement Service. All rights reserved.

[Help](#) | [Contact Us](#) | [Sitemap](#)



Republic of the Philippines
CARLOS HILADO MEMORIAL STATE UNIVERSITY
 Talisay City, Negros Occidental
 Mobile Phone Number: (0920) 583 3046
bac.sec@chmsu.edu.ph

REQUEST FOR QUOTATION

Page 1 of 6

Date: APRIL 29, 2026

Quotation No. 26-138

Please quote your lowest price on the item/s listed below, stating the shortest time of delivery and submit your quotation duly signed by your representative not later than _____ in the return envelope attached herewith.

DR. MA. RIZA T. MANALO
 BAC Chairperson

NOTE:

1. ALL ENTRIES MAY BE TYPEWRITTEN OR LEGIBLY HANDWRITTEN
2. DELIVERY PERIOD WITHIN 45 CALENDAR DAYS
3. WARRANTY SHALL BE FOR A PERIOD OF SIX (6) MONTHS FOR SUPPLIES & MATERIALS, ONE (1) YEAR FOR EQUIPMENT, FROM DATE OF ACCEPTANCE BY THE PROCURING ENTITY
4. PRICE VALIDITY SHALL BE FOR A PERIOD OF _____ CALENDAR DAYS
5. G-EPS REGISTRATION CERTIFICATE SHALL BE ATTACHED UPON SUBMISSION OF THE QUOTATION
6. BIDDERS SHALL SUBMIT ORIGINAL BROCHURES SHOWING CERTIFICATIONS OF THE PRODUCT BEING OFFERED

ITEM NO.	DESCRIPTION OF WORKS	QTY.	UNIT	MATERIAL COST		LABOR COST		TOTAL COST
				Unit Cost	Material Sub-Total Cost	Unit Cost	Labor Sub-Total Cost	
	ONE (1) LOT							
	LABOR AND MATERIALS FOR THE INSTALLATION OF DRY WALL PARTITION AND WINDOW GRILLS FOR RAC SHOP LABORATORY EXTENSION AT TALISAY CAMPUS							
	SCOPE OF WORKS							
1.0	GENERAL REQUIREMENTS							
1.1	Mobilization and Demobilization							
1.2	Safety Occupational Hazards							
1.3	Site Clearing, Cleaning and Hauling							
2.0	ARCHITECTURAL WORKS							
2.1	CARPENTRY WORKS							
2.1.1	Fabrication and Installation of Dry Wall Partition (Double Wall)							
2.1.2	Fabrication and Installation of 2 unit Door, Door Jamb with complete Accessories (See Detail and Location Plan)							
2.2	PAINTING WORKS							
2.2.1	Surface Preparation and Painting of Dry Wall Partition							

Date _____ By _____
 Released (BAC) _____
 Returned (Supplier) _____

 Printed Name/Signature

 Tel. No./Cellphone No.

 Date



Republic of the Philippines
CARLOS HILADO MEMORIAL STATE UNIVERSITY
 Talisay City, Negros Occidental
 Mobile Phone Number: (0920) 583 3046
bac.sec@chmsu.edu.ph

REQUEST FOR QUOTATION

Page 2 of 6

Date: APRIL 29, 2026

Quotation No. 26-138

Please quote your lowest price on the item/s listed below, stating the shortest time of delivery and submit your quotation duly signed by your representative not later than _____ in the return envelope attached herewith.

DR. MA. RIZA T. MANALO
 BAC Chairperson

NOTE:

1. ALL ENTRIES MAY BE TYPEWRITTEN OR LEGIBLY HANDWRITTEN
2. DELIVERY PERIOD WITHIN 45 CALENDAR DAYS
3. WARRANTY SHALL BE FOR A PERIOD OF SIX (6) MONTHS FOR SUPPLIES & MATERIALS, ONE (1) YEAR FOR EQUIPMENT, FROM DATE OF ACCEPTANCE BY THE PROCURING ENTITY
4. PRICE VALIDITY SHALL BE FOR A PERIOD OF _____ CALENDAR DAYS
5. G-EPS REGISTRATION CERTIFICATE SHALL BE ATTACHED UPON SUBMISSION OF THE QUOTATION
6. BIDDERS SHALL SUBMIT ORIGINAL BROCHURES SHOWING CERTIFICATIONS OF THE PRODUCT BEING OFFERED

ITEM NO.	DESCRIPTION OF WORKS	QTY.	UNIT	MATERIAL COST		LABOR COST		TOTAL COST
				Unit Cost	Material Sub-Total Cost	Unit Cost	Labor Sub-Total Cost	
2.2.2	Surface Preparation and Painting of New Door and Door Jambs							
2.2.3	Surface Preparation and Painting of Window Grills							
3.0	MASONRY and TOUCH-UP PAINT WORKS							
3.1	Touch-up paint and masonry works (for Installation of grills)							
4.0	STEEL WORKS							
4.1	Fabrication and Installation of 4 Units Window Grills for RAC Shop Laboratory Extension (See Detailed Plan)							
5.0	MISCELLANEOUS WORKS							
BILL OF QUANTITIES								
1.0	GENERAL REQUIREMENTS							
1.1	Mobilization and Demobilization	1.00	lot					
1.2	Safety Occupational Hazards	1.00	lot					
1.3	Site Clearing, Cleaning and Hauling	1.00	lot					
	Sub-total, 1.0 (GENERAL REQUIREMENTS)							

Date

By

Released (BAC) _____

Returned (Supplier) _____

Printed Name/Signature

Tel. No./Cellphone No.

Date



Republic of the Philippines
CARLOS HILADO MEMORIAL STATE UNIVERSITY
Talisay City, Negros Occidental
Mobile Phone Number: (0920) 583 3046
bac.sec@chmsu.edu.ph

REQUEST FOR QUOTATION

Page 3 of 6

Date: APRIL 29, 2026

Quotation No. 26-138

Please quote your lowest price on the item/s listed below, stating the shortest time of delivery and submit your quotation duly signed by your representative not later than _____ in the return envelope attached herewith.

DR. MA. RIZA T. MANALO
BAC Chairperson

NOTE:

1. ALL ENTRIES MAY BE TYPEWRITTEN OR LEGIBLY HANDWRITTEN
2. DELIVERY PERIOD WITHIN 45 CALENDAR DAYS
3. WARRANTY SHALL BE FOR A PERIOD OF SIX (6) MONTHS FOR SUPPLIES & MATERIALS, ONE (1) YEAR FOR EQUIPMENT, FROM DATE OF OF ACCEPTANCE BY THE PROCURING ENTITY
4. PRICE VALIDITY SHALL BE FOR A PERIOD OF _____ CALENDAR DAYS
5. G-EPS REGISTRATION CERTIFICATE SHALL BE ATTACHED UPON SUBMISSION OF THE QUOTATION
6. BIDDERS SHALL SUBMIT ORIGINAL BROCHURES SHOWING CERTIFICATIONS OF THE PRODUCT BEING OFFERED

ITEM NO.	DESCRIPTION OF WORKS	QTY.	UNIT	MATERIAL COST		LABOR COST		TOTAL COST
				Unit Cost	Material Sub-Total Cost	Unit Cost	Labor Sub-Total Cost	
2.0	ARCHITECTURAL WORKS							
2.1	CARPENTRY WORKS							
	DRY WALL PARTITIONS, DOOR, DOOR JAMB & ACCESSORIES							
2.1.1	1/4"x 4'x 8' Fiber Cement Board	26	shts					
2.1.2	Super thin cutting disc 4"	3	box					
2.1.3	Grinding stone 4"	5	pcs					
2.1.4	1/8" x 1/2" Blind Rivets	2	box					
2.1.5	3"x2"x3m thk. Metal Studs	32	lgth					
2.1.6	Door Knob with lockset (Lever type)	2	pcs.					
2.1.7	1.00m Width x 2.10m Height, Wood Panel Door with Door Jamb, Door Hinges Heavy Duty and Door Knob (Lever type) with Lock	2	set					
	Sub-total, 2.1 (CARPENTRY WORKS)							
2.2	PAINTING WORKS							
	DRY WALL PARTITIONS, DOOR, DOOR JAMB & ACCESSORIES and GRILLS							
2.2.1	Metal Primer, Gray / Red Oxide (for Grills)	4.00	gal					
2.2.2	Enamel Top Coat paint, Black (for Grills)	3.00	gal					

Date

By

Released (BAC) _____

Returned (Supplier) _____

Printed Name/Signature

Tel. No./Cellphone No.

Date



Republic of the Philippines
CARLOS HILADO MEMORIAL STATE UNIVERSITY
 Talisay City, Negros Occidental
 Mobile Phone Number: (0920) 583 3046
bac.sec@chmsu.edu.ph

REQUEST FOR QUOTATION

Page 4 of 6

Date: APRIL 29, 2026
 Quotation No. 26-138

Please quote your lowest price on the item/s listed below, stating the shortest time of delivery and submit your quotation duly signed by your representative not later than _____ in the return envelope attached herewith.

DR. MA. RIZA T. MANALO
 BAC Chairperson

NOTE:

1. ALL ENTRIES MAY BE TYPEWRITTEN OR LEGIBLY HANDWRITTEN
2. DELIVERY PERIOD WITHIN 45 CALENDAR DAYS
3. WARRANTY SHALL BE FOR A PERIOD OF SIX (6) MONTHS FOR SUPPLIES & MATERIALS, ONE (1) YEAR FOR EQUIPMENT, FROM DATE OF ACCEPTANCE BY THE PROCURING ENTITY
4. PRICE VALIDITY SHALL BE FOR A PERIOD OF _____ CALENDAR DAYS
5. G-EPS REGISTRATION CERTIFICATE SHALL BE ATTACHED UPON SUBMISSION OF THE QUOTATION
6. BIDDERS SHALL SUBMIT ORIGINAL BROCHURES SHOWING CERTIFICATIONS OF THE PRODUCT BEING OFFERED

ITEM NO.	DESCRIPTION OF WORKS	QTY.	UNIT	MATERIAL COST		LABOR COST		TOTAL COST
				Unit Cost	Material Sub-Total Cost	Unit Cost	Labor Sub-Total Cost	
2.2.3	Flat Latex, White	8.00	gal					
2.2.4	Semi-gloss Latex, White	8.00	gal					
2.2.5	Paint tray	5.00	pcs					
2.2.6	Baby Roller	6.00	pcs					
2.2.7	2" Paint Brush	5.00	pcs					
2.2.8	#120 Sanding paper	4.00	pcs					
2.2.9	#60 Sanding paper	4.00	pcs					
2.2.10	#400 Sanding paper	5.00	pcs					
2.2.11	Waste Cotton	5.00	kls					
2.2.12	Paint Thinner	4.00	gal					
2.2.13	Masonry Putty	6.00	liters					
2.2.14	Masking Tape 1"	9.00	roll					
2.2.15	Wood Stain (Mahogany) (for Proposed 2 Unit Door)	4.00	liter					
2.2.16	Sanding Sealer	4.00	liter					
2.2.17	Lacquer thinner	2.00	gal					
	Sub-total, 2.2 (PAINTING WORKS)							
3.0	MASONRY and TOUCH-UP PAINT WORKS							
3.1	Touch-up paint and masonry works (for Installation of grills)	1.00	lot					
	Sub-total, 3.0 (MASONRY and TOUCH-UP PAINT WORKS)							

Date _____ By _____

Released (BAC) _____
 Returned (Supplier) _____

Printed Name/Signature

Tel. No./Cellphone No.

Date



Republic of the Philippines
CARLOS HILADO MEMORIAL STATE UNIVERSITY
 Talisay City, Negros Occidental
 Mobile Phone Number: (0920) 583 3046
bac.sec@chmsu.edu.ph

REQUEST FOR QUOTATION

Page 5 of 6

Date: APRIL 29, 2026

Quotation No. 26-138

Please quote your lowest price on the item/s listed below, stating the shortest time of delivery and submit your quotation duly signed by your representative not later than _____ in the return envelope attached herewith.

DR. MA. RIZA T. MANALO
 BAC Chairperson

NOTE:

1. ALL ENTRIES MAY BE TYPEWRITTEN OR LEGIBLY HANDWRITTEN
2. DELIVERY PERIOD WITHIN 45 CALENDAR DAYS
3. WARRANTY SHALL BE FOR A PERIOD OF SIX (6) MONTHS FOR SUPPLIES & MATERIALS, ONE (1) YEAR FOR EQUIPMENT, FROM DATE OF ACCEPTANCE BY THE PROCURING ENTITY
4. PRICE VALIDITY SHALL BE FOR A PERIOD OF _____ CALENDAR DAYS
5. G-EPS REGISTRATION CERTIFICATE SHALL BE ATTACHED UPON SUBMISSION OF THE QUOTATION
6. BIDDERS SHALL SUBMIT ORIGINAL BROCHURES SHOWING CERTIFICATIONS OF THE PRODUCT BEING OFFERED

ITEM NO.	DESCRIPTION OF WORKS	QTY.	UNIT	MATERIAL COST		LABOR COST		TOTAL COST
				Unit Cost	Material Sub-Total Cost	Unit Cost	Labor Sub-Total Cost	
4.0	STEEL WORKS							
	FABRICATION AND INSTALLATION OF 8 UNITS WINDOW GRILLS FOR RAC SHOP LABORATORY EXTENSION							
4.1	10mm x 10mm x 6m Steel Square Bar	85.00	lghts.					
4.2	6013 Welding Rod	12.00	kgs.					
4.3	4"Ø Steel Cutting Disc	15.00	pcs					
4.4	4"Ø Grinding Stone	6.00	pcs					
	Sub-total, 4.0 (STEEL WORKS)							
5.0	MISCELLANEOUS WORKS							
	FOR ALL OTHER ITEMS that are not included on listed Bill of Quantities in your Bid but are deemed necessary for the completion of the works.	1.00	lot					
	Sub-total, 5.0 (MISCELLANEOUS WORKS)							
	PROJECT DURATION: 45 CALENDAR DAYS							
	Note: Attach Certificate of Site Inspection							

Date

By

Released (BAC) _____

Returned (Supplier) _____

Printed Name/Signature

Tel. No./Cellphone No.

Date



Republic of the Philippines
CARLOS HILADO MEMORIAL STATE UNIVERSITY
 Talisay City, Negros Occidental
 Mobile Phone Number: (0920) 583 3046
bac.sec@chmsu.edu.ph

REQUEST FOR QUOTATION

Page 6 of 6

Date: APRIL 29, 2026
 Quotation No. 26-138

Please quote your lowest price on the item/s listed below, stating the shortest time of delivery and submit your quotation duly signed by your representative not later than _____ in the return envelope attached herewith.

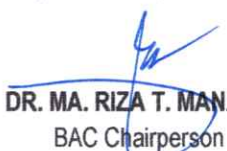
DR. MA. RIZA T. MANALO
 BAC Chairperson

NOTE:

1. ALL ENTRIES MAY BE TYPEWRITTEN OR LEGIBLY HANDWRITTEN
2. DELIVERY PERIOD WITHIN 45 CALENDAR DAYS
3. WARRANTY SHALL BE FOR A PERIOD OF SIX (6) MONTHS FOR SUPPLIES & MATERIALS, ONE (1) YEAR FOR EQUIPMENT, FROM DATE OF ACCEPTANCE BY THE PROCURING ENTITY
4. PRICE VALIDITY SHALL BE FOR A PERIOD OF _____ CALENDAR DAYS
5. G-EPS REGISTRATION CERTIFICATE SHALL BE ATTACHED UPON SUBMISSION OF THE QUOTATION
6. BIDDERS SHALL SUBMIT ORIGINAL BROCHURES SHOWING CERTIFICATIONS OF THE PRODUCT BEING OFFERED

ITEM NO.	DESCRIPTION OF WORKS	QTY.	UNIT	MATERIAL COST		LABOR COST		TOTAL COST
				Unit Cost	Material Sub-Total Cost	Unit Cost	Labor Sub-Total Cost	
	A. TOTAL DIRECT COST							
	B. CONSUMABLES:							
	C. SUPERVISION AND ADMINISTRATION:							
	D. TOTAL INDIRECT COST (B+C):							
	E. TOTAL COST (A+D)							
	F. VAT (12% OF ITEM E):							
	GRAND TOTAL OF PROJECT COST:							
	*****NOTHING FOLLOWS*****							
	TOTAL ABC = Php 210,000.00							
	PROPOSED INSTALLATION OF DRY WALL PARTITION AND WINDOW GRILLS FOR RAC SHOP LABORATORY EXTENSION TALISAY CAMPUS/ A. LOPEZ (DEAN-CIT)							
	PR# 26-089-0219 02-19-26							
	INCOME 104-164-26-04 04-06-26							

Released (BAC) _____ Date _____ By _____
 Returned (Supplier) _____

 Printed Name/Signature

 Tel. No./Cellphone No.

 Date

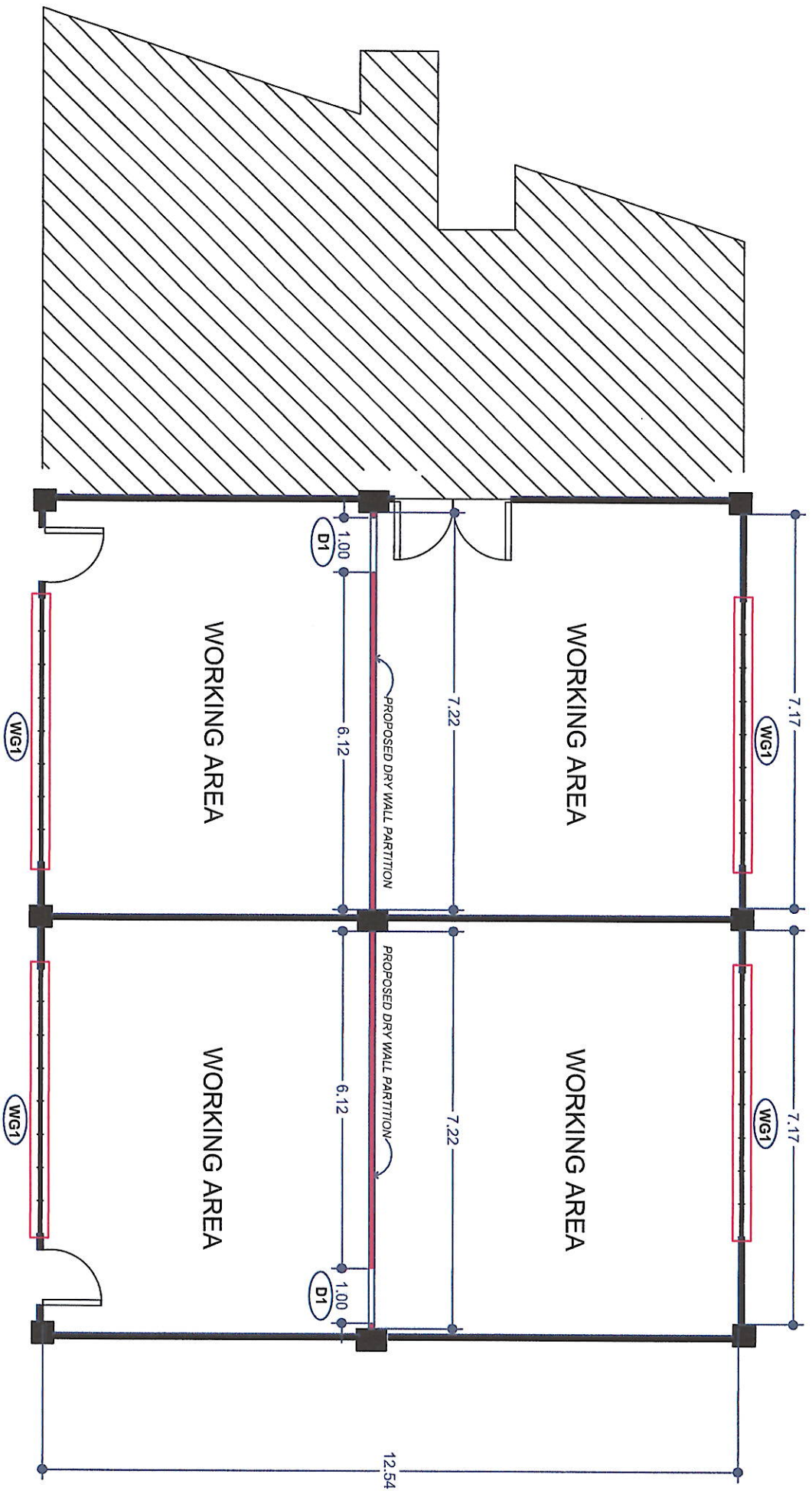

FLOOR PLAN
SCALE 1:100M

 Republic of the Philippines CARLOS HILADO MEMORIAL STATE UNIVERSITY Negros Occidental	PROJECT TITLE: INSTALLATION OF DRY WALL PARTITION AND WINDOW GRILLS FOR RAC SHORT LABORATORY EXTENSION	PREPARED BY:  KRISTELL JOY REBENSTRANIE UNIVERSITY DRAFTSMAN	CHECKED BY:  DERRICO O. CHAVEZ ENGINEER
OFFICE OF THE DEPARTMENTAL ENGINEERING AND MANAGEMENT	PROJECT LOCATION: CHASSU MAIN CAMPUS	APPROVED BY:  ROSALINDA S. TULLIA, JD VICE PRESIDENT FOR ADMINISTRATION AND FINANCE	APPROVED BY:  NOBERTOR M. GULANBAN, Ph.D SUC PRESIDENT III
		ENGINEER:  JHON J. M. OCHOA ENGINEER	ENGINEER:  JHON J. M. OCHOA ENGINEER
		DIRECTOR:  JHON J. M. OCHOA DIRECTOR	DIRECTOR:  JHON J. M. OCHOA DIRECTOR
		A	2

PROPOSED FABRICATION AND
INSTALLATION OF DRY WALL PARTITION
WITH PANEL DOOR AND DOOR JAMB

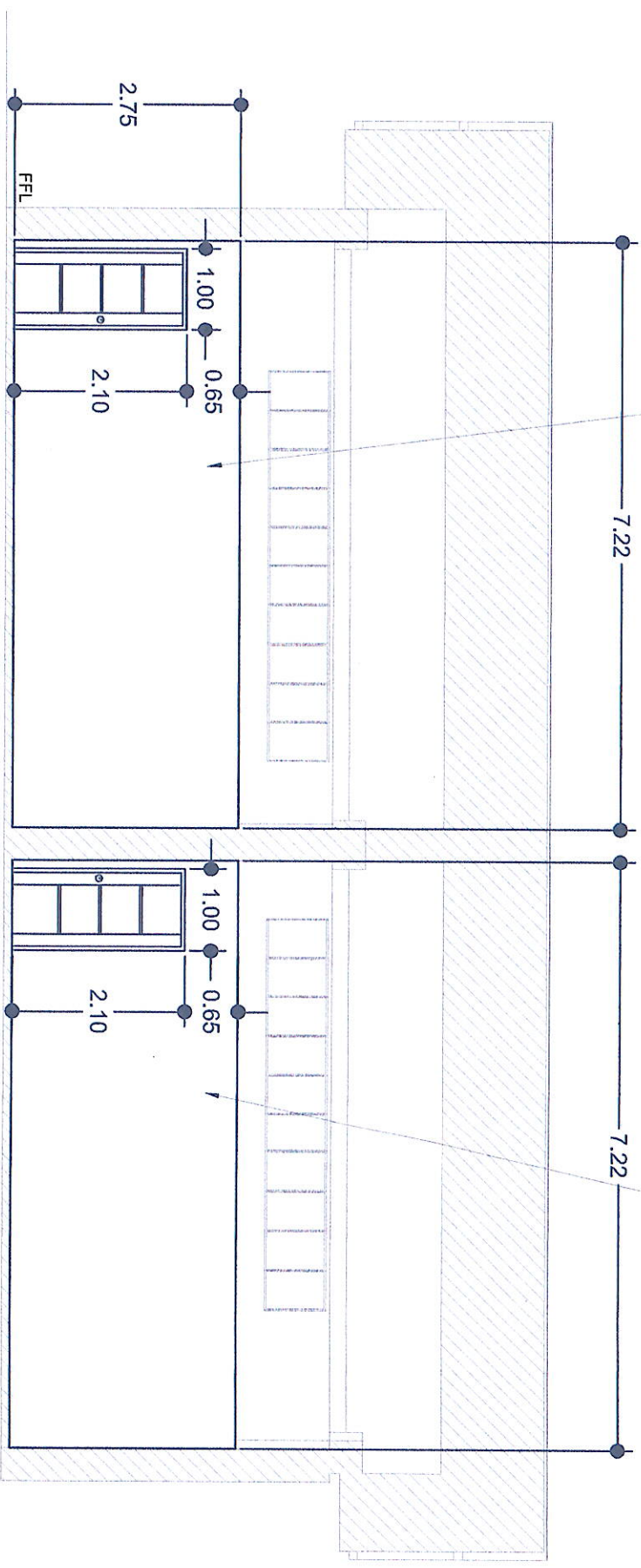

PROPOSED FABRICATION AND
INSTALLATION OF DRY WALL PARTITION
WITH PANEL DOOR AND DOOR JAMB

DRY WALL PARTITION ELEVATION
SCALE 1:130M



Republic of the Philippines
CARLOS HILADO MEMORIAL
STATE UNIVERSITY
Naga City, Sorsogon

PROJECT TITLE:
**INSTALLATION OF DRY WALL PARTITION AND
WINDOW GRILLS FOR RACS SHOT LABORATORY
EXTENSION**

PREPARED BY:
Kristell R. Pateran
KRISTELL R. PATERANIE
UNIV. ASSTY. DRAFTSMAN

CHECKED BY:
Engr. O. Chavez
ENGR. O. CHAVEZ
REGISTERED ARCHITECT
NO. 10100
DIRECTOR

Engr. Jun J. Marcillo
ENGR. JUN J. MARCILLO
DIRECTOR

Rosalinda S. Sevilla
ROSALINDA S. SEVILLA, J.D.
VICE PRESIDENT FOR ADMINISTRATION AND FINANCE

APPROVED BY:
Norberto P. Mangulabnan
NORBERTO P. MANGULABNAN, PH.D.
SUC PRESIDENT III

SHEET NO.: **A**
PAGE NO.: **3**

OFFICE OF MATERIALS MANAGEMENT
AND MAINTENANCE

WINDOW OPENING (4.80M x 1.80M)

OFF-SET FROM WINDOW LINE (0.10M)
see blow-up detail

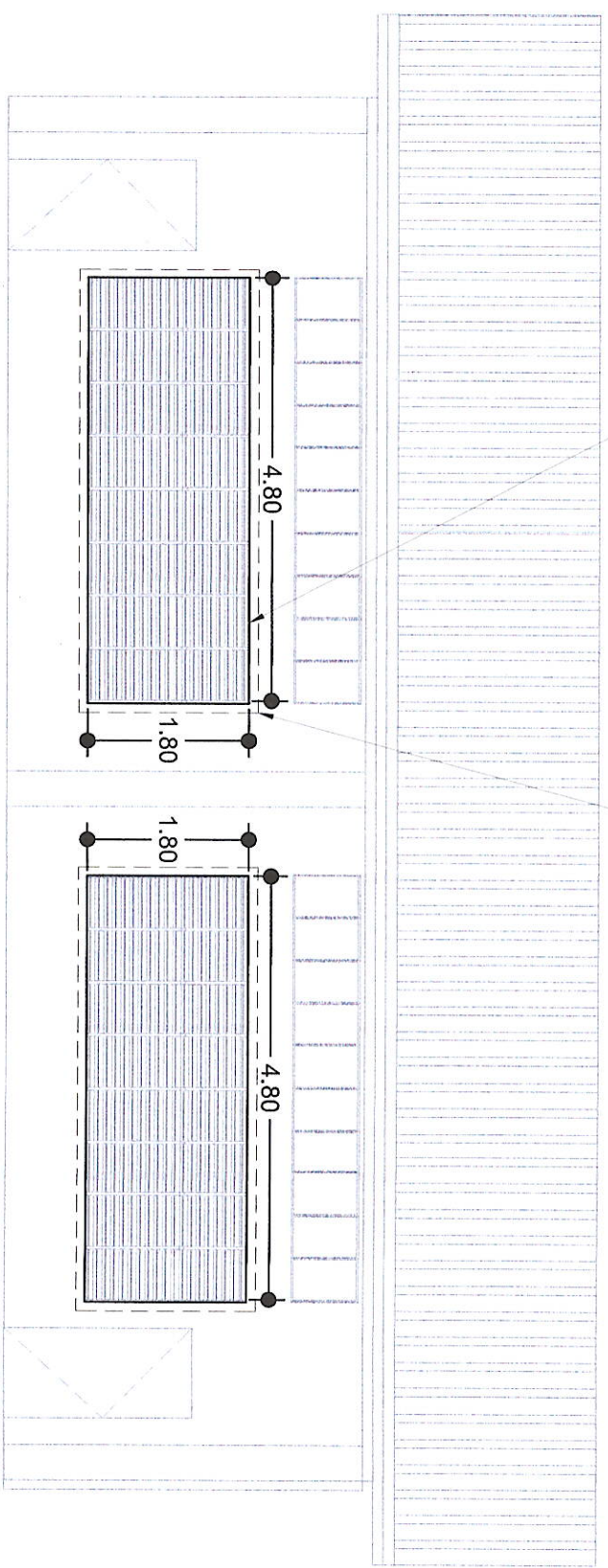

WINDOW OPENING ELEVATION
SCALE 1:130M

 <p>Republic of the Philippines CARLOS HILADO MEMORIAL STATE UNIVERSITY Negros Occidental</p>		<p>PROJECT TITLE: INSTALLATION OF DRY WALL PARTITION AND WINDOW GRILLS FOR RAC SHOP LABORATORY EXTENSION</p>		<p>PROJECT LOCATION: CHASU MAIN CAMPUS</p>	
<p>PREPARED BY: <i>Kristel R. Everante</i> UNIVERSITY DRAFTSMAN</p>		<p>CHECKED BY: <i>Engr. G. M. Chaves</i> ENGR. G. M. CHAVES REGISTERED PROFESSIONAL ENGINEER FROM</p>		<p>APPROVED BY: <i>Rosalinda S. Tuvilla, JD</i> ROSA LINDA S. TUVILLA, JD VICE PRESIDENT FOR ADMINISTRATION AND FINANCE</p>	
<p>APPROVED BY: <i>Norberto Mangulabnan, Ph.D</i> NORBERTO MANGULABNAN, Ph.D SUC PRESIDENT III</p>		<p>APPROVED BY: <i>Engr. G. M. Chaves</i> ENGR. G. M. CHAVES REGISTERED PROFESSIONAL ENGINEER FROM</p>		<p>APPROVED BY: <i>Engr. G. M. Chaves</i> ENGR. G. M. CHAVES REGISTERED PROFESSIONAL ENGINEER FROM</p>	
<p>SHEET NO.: A</p>		<p>SHEET NO.: A</p>		<p>PAGE NO.: 4</p>	

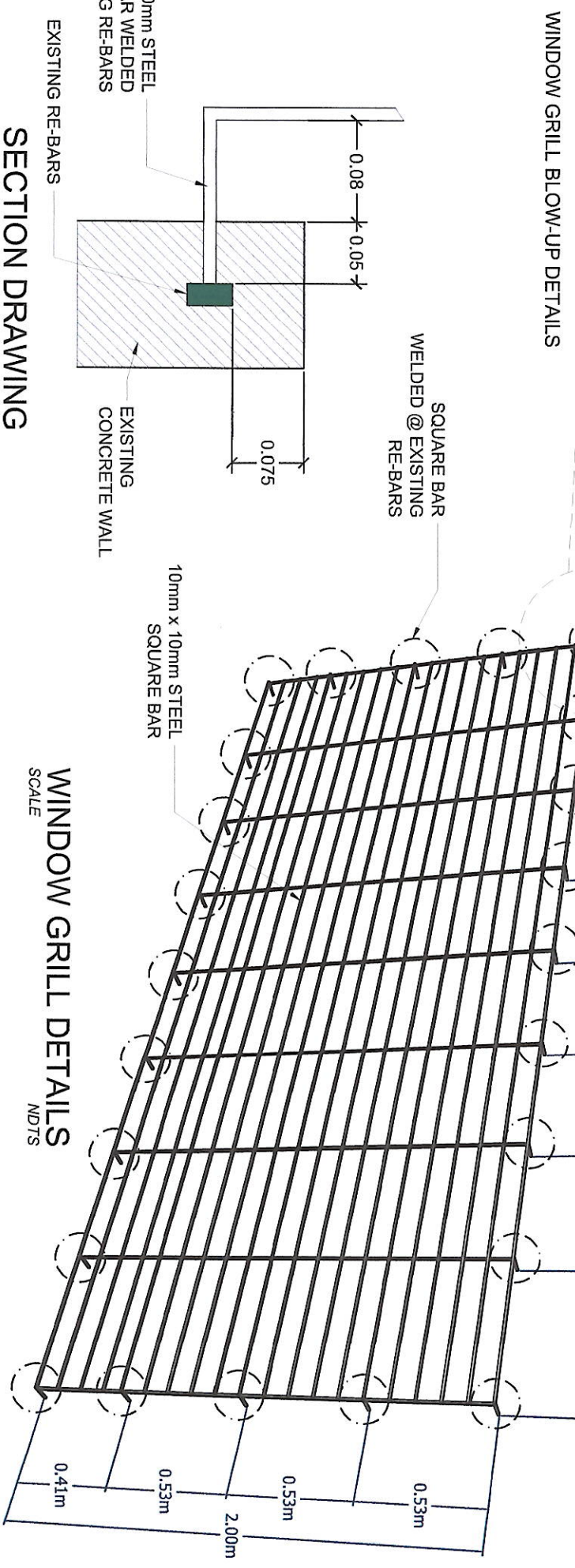
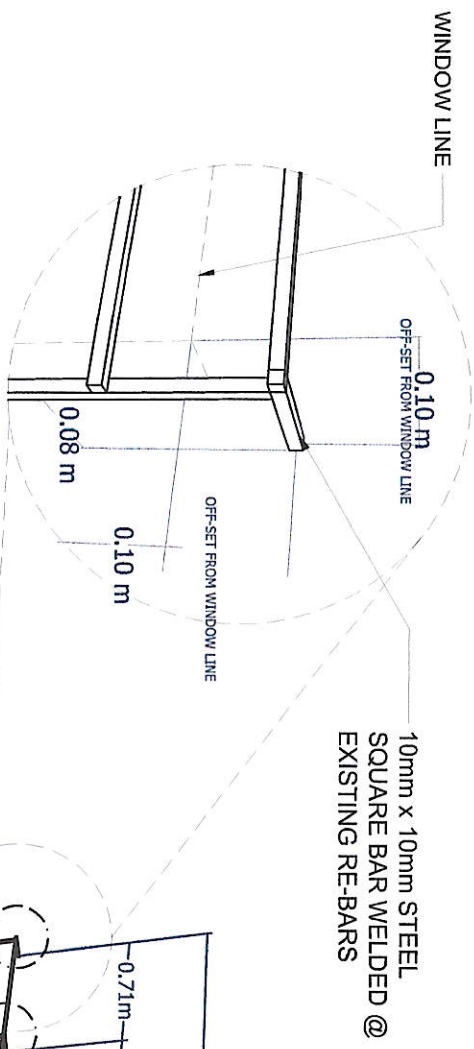

 <p>Republic of the Philippines CARLOS HILADO MEMORIAL STATE UNIVERSITY Negros Occidental</p>		<p>PROJECT TITLE: INSTALLATION OF DRY WALL PARTITION AND WINDOW GRILLS FOR RACS SHOP LABORATORY EXTENSION</p>		<p>PREPARED BY: KRISTINE O. R. PEKERANIE UNIVERSITY DRAFTSMAN</p>		<p>CHECKED BY: ENR. GABRIEL O. CHAVE REGISTERED PROFESSIONAL ENGINEER</p>		<p>DIRECTOR PDM ENR. ADN-JUN J. MARTINEZ</p>		<p>APPROVED BY: NORBERTO P. MINGULABAN, PH.D. SUC PRESIDENT III</p>		<p>SHEET NO: A</p>		<p>PAGE NO: 5</p>	
<p>OFFICE OF THE PHYSICAL PLANNING AND MANAGEMENT</p>		<p>PROJECT LOCATION: CHINU MAIN CAMPUS</p>		<p>UNIVERSITY DRAFTSMAN</p>		<p>REGISTERED PROFESSIONAL ENGINEER</p>		<p>DIRECTOR FOR ADMINISTRATION AND FINANCE</p>		<p>SUC PRESIDENT III</p>		<p>A</p>		<p>5</p>	